



Père Noël Santa Claus

Nicolas TERRY

Nov 2003

<http://design.origami.fr>



Un carré de 23cm donne un modèle de 12cm x 10cm
A square of 23cm makes a model of 12cm x 10cm

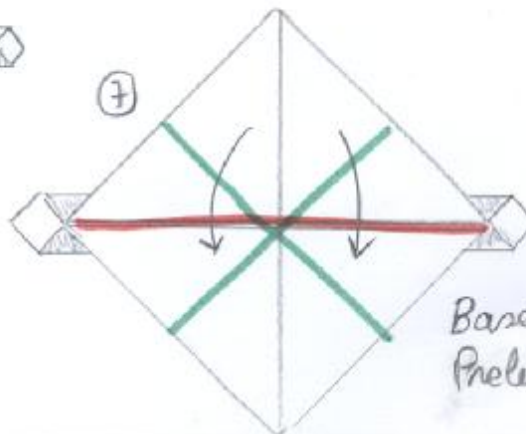
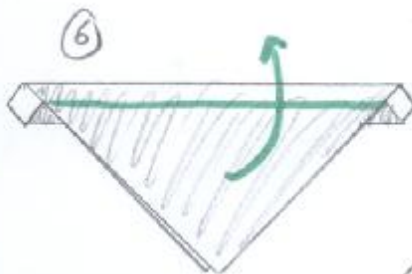
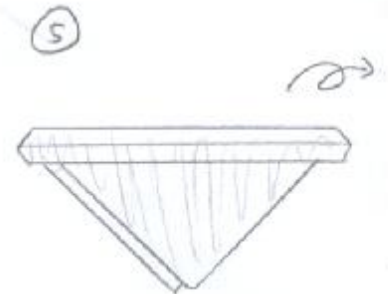
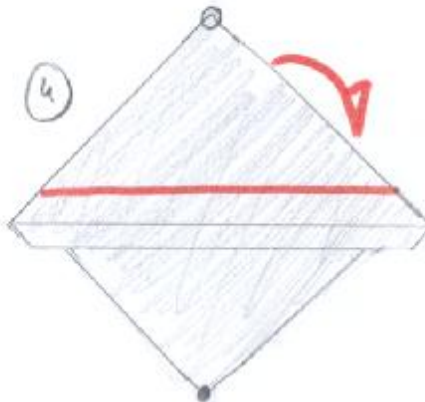
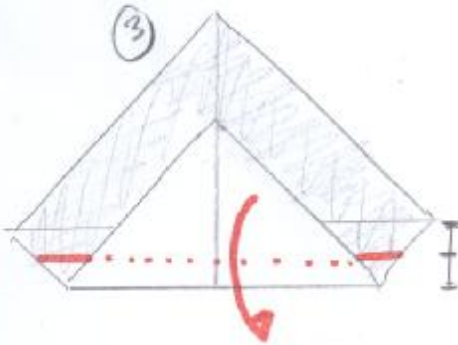
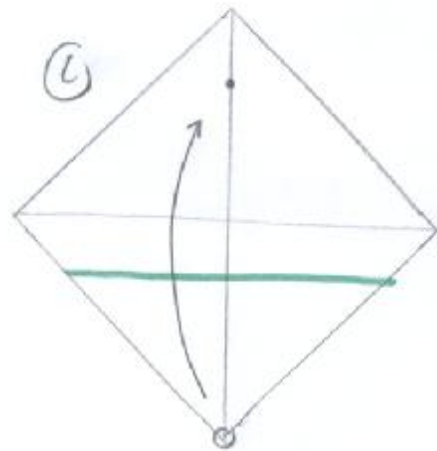
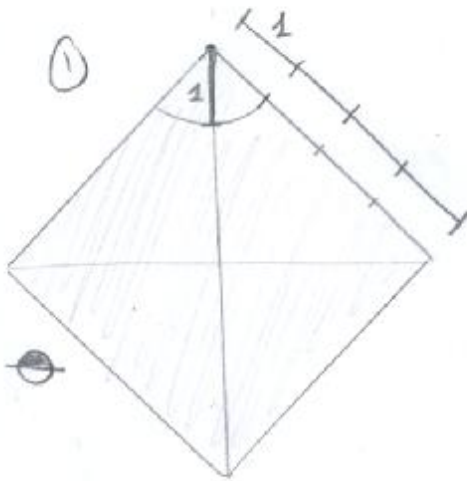

Base préliminaire
Preliminary base

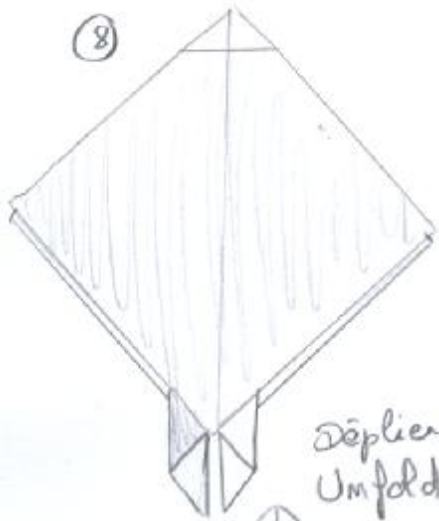

Déplier
Unfold

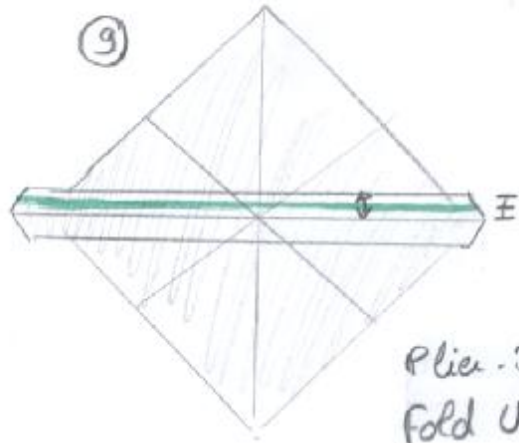

Plier - Déplier
Fold Unfold

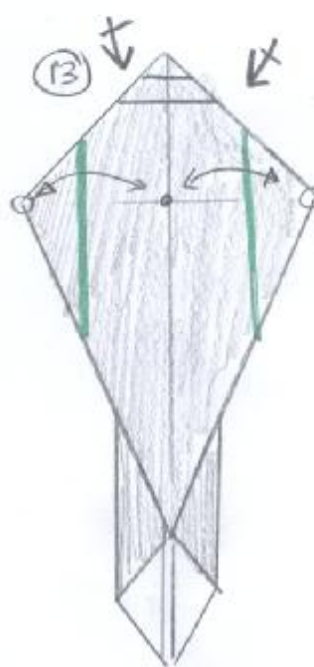
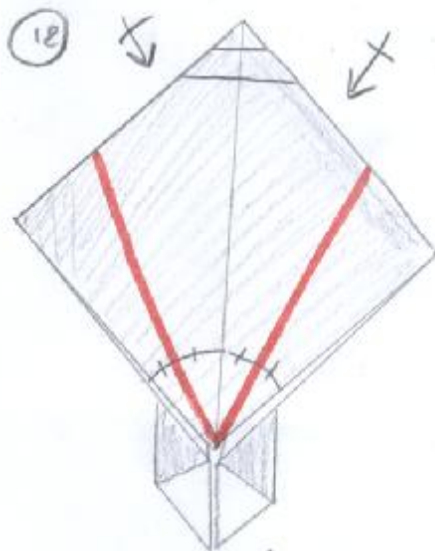
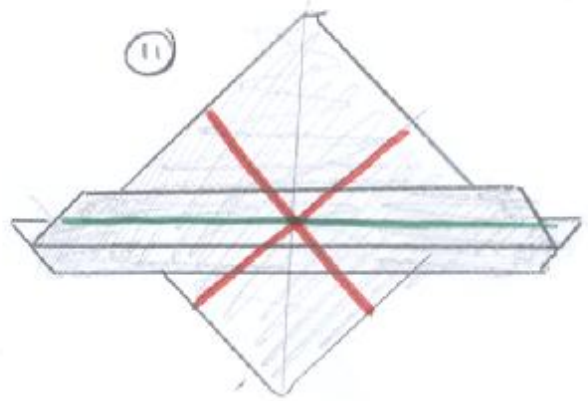
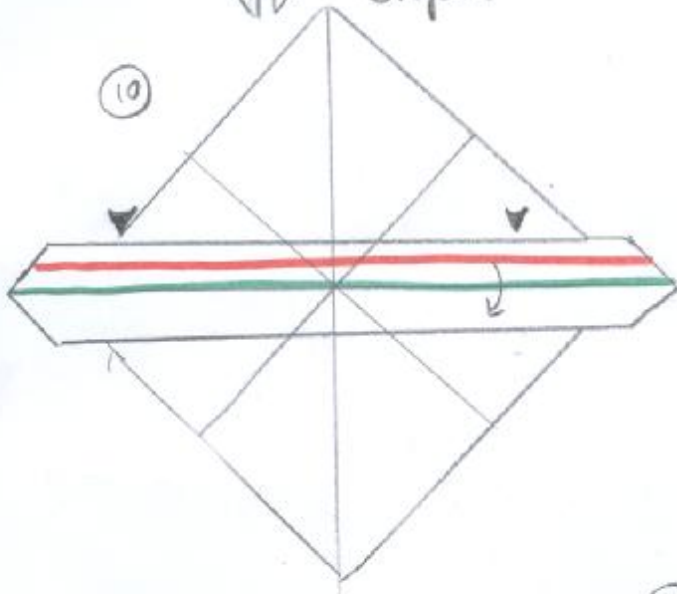

Plier - Déplier
Fold Unfold

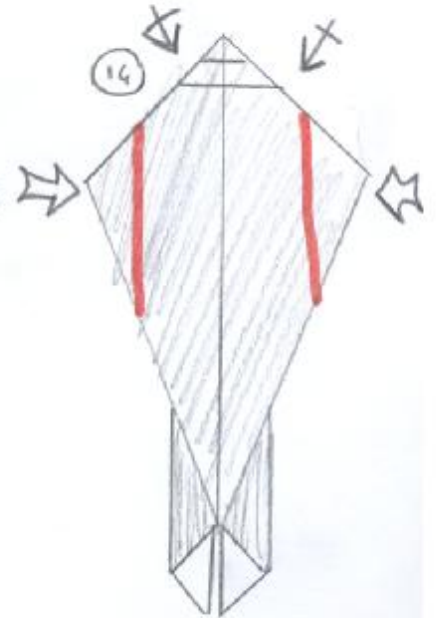

OPEN SINK

Reverse fold
Angle bisector
Plis inverses intérieurs
ou les bissectrices

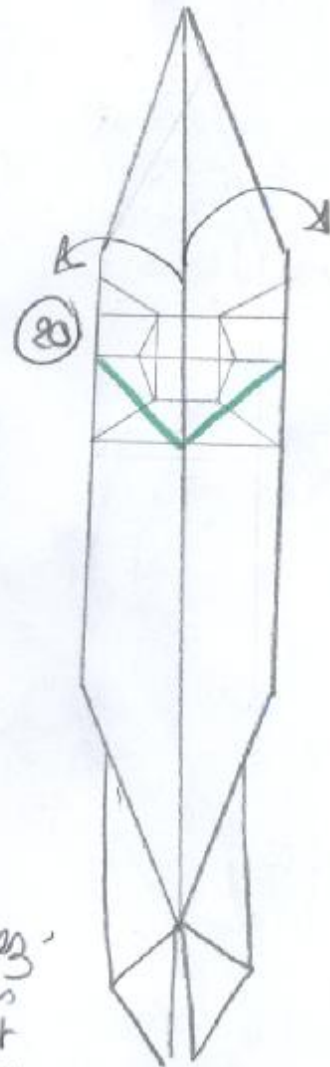
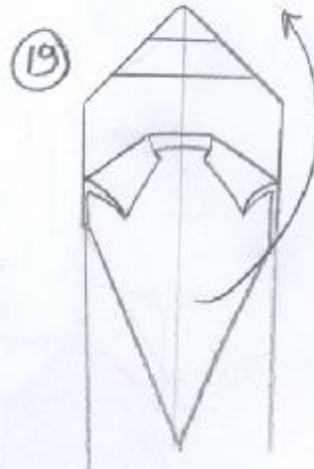
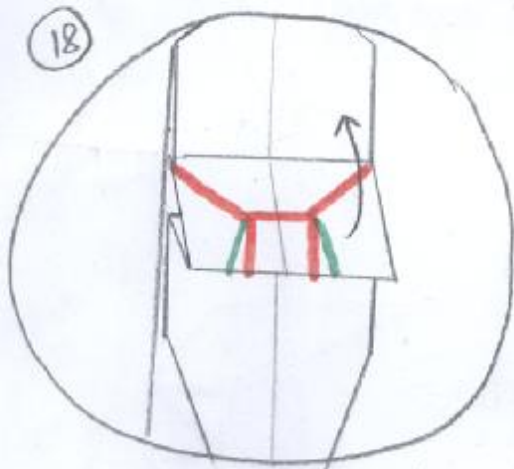
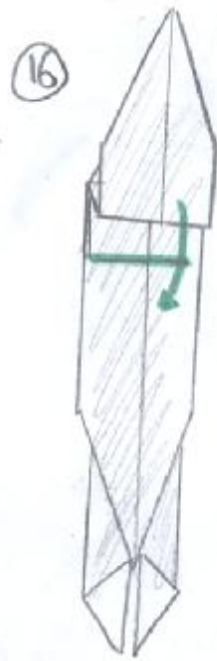
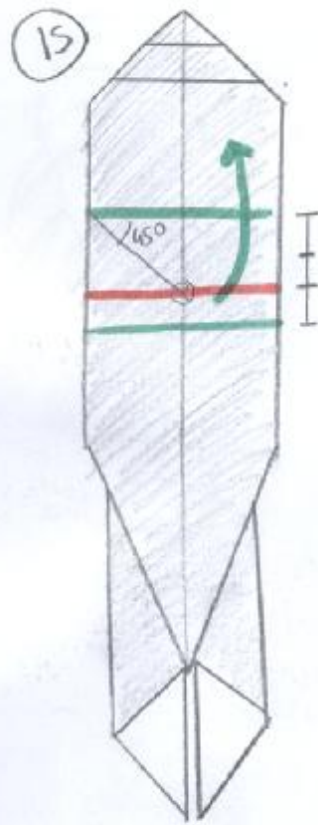

- Former le nez et les mustaches
- Form the nose and the mustaches

- Lever la pointe en dépliant le nez et les mustaches
- Fold up the point unfolding the nose and the mustaches

- OUVRIE les volets
- open the flaps

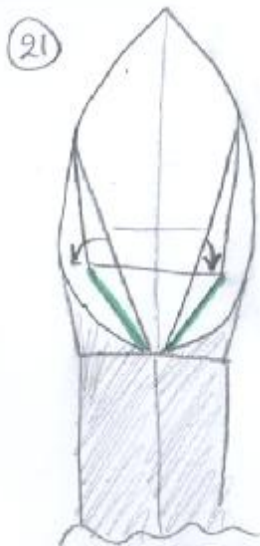

- Fold the 2 small inside flaps
- Plier les 2 petits volets internes

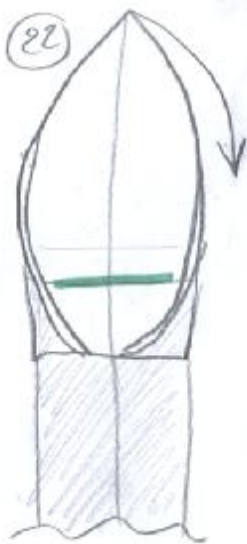

- Replier en reformant le nez et les moustaches
- Pleat-fold, folding in como turn the nose and the mustaches



- Redoler la Barbe
- Shape the Beard.



- Fold up the Back Point
- Lever la pointe de derriere

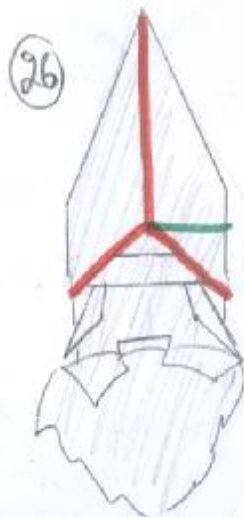

- Pli Oreille de lapin
- Rabbit ear Fold

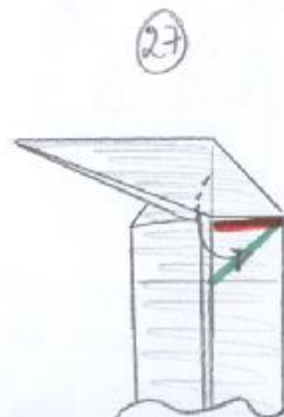

- Sortir le papier cache
- Pull out the hidden flap

- Le Volet devient 3D
- The flap becomes 3D

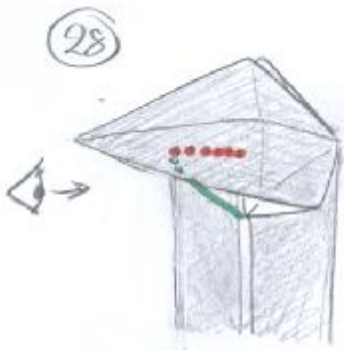

- Répéter l'opération sur l'autre volet
- Repeat the step on the other flap

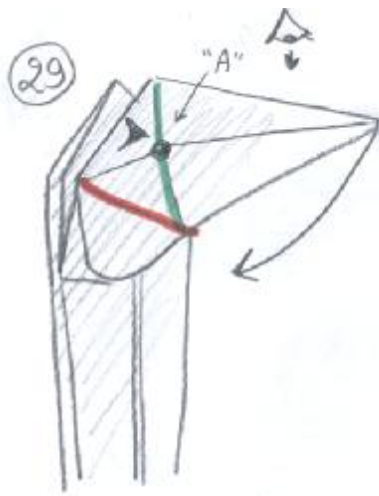

- Enfoncer "A" rabattant la pointe sur le côté
- Push "A", folding the point to the left



- Vue de dessus
- View on top.



- Plus un vers à gauche et un vers à droite 3 à droite
- Reverse fold - 3 flaps at the left, 3 at the right

- Écarter les volets l'épaule devient 3D
- Stretch the flaps The shoulder becomes 3D

37

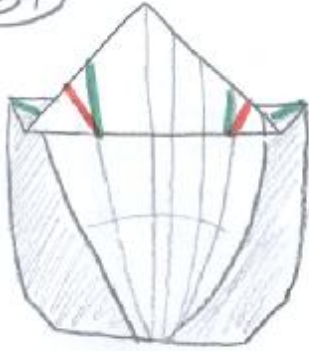

38

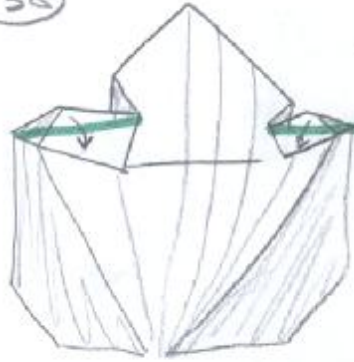

39



- Créer un effet 3D en modelant les doigts
- Create a 3D effect shaping the fingers

60



- Modeler le bras
- Shape the arm

61



Résultat Final !
The Result !

Joyeux Noël !
Happy Christmas !

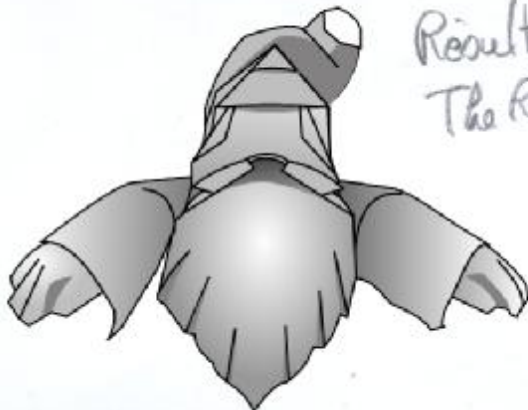

N. TERRY

<http://design.origami.free.fr>

